

centor®



SIE Eco-Screen™ for any door or window type

centor®

## Contents

Screening problems solved .....	1
Considered design .....	2
Built tough and tested .....	5
Interview with architect James Russell .....	6
Interview with architect Shawn Godwin .....	7
Architectural detail .....	8
S1E with folding system .....	8
Brick veneer .....	10
Concrete block .....	12
Timber cladding .....	14
S1E with sliding system .....	16
Brick veneer .....	18
Concrete block .....	20
Timber cladding .....	22



S1E Eco-Screen™ max frame size	
<b>Single function system</b>	
Insect screen	3.2m (H) x 3.9m (W)
Blind	2.45m (H) x 3.9m (W)
<b>Double system</b>	
Insect screen	3.2m (H) x 7.6m (W)
Blind	2.45m (H) x 7.6m (W)
<b>Multi-function system</b>	2.45m (H) x 3.9m (W)

The S1E Eco-Screen™ from Centor is a revolutionary product providing eco-friendly retractable insect screening and solar control with fingertip operation. This product is the evolution of Centor's award-winning S1 Insect Screen.

S1E allows homeowners to have complete control of their living environment. Used singly or paired together S1E is ready for use whatever the season or time of day. S1E retracts horizontally and discreetly into its frame when not in use – a revolutionary solution for those who refuse to compromise on style.

For a single function system up to 3.9m wide choose an insect screen to 3.2m high or a sun filter blind to 2.45m high.

Create a multi-function system selecting both fabrics for a two-in-one screening solution for openings up to 3.9m wide and 2.45m high. The insect screen and sun filter fabrics prevent insects entering the home and provide solar control.

#### Single function system

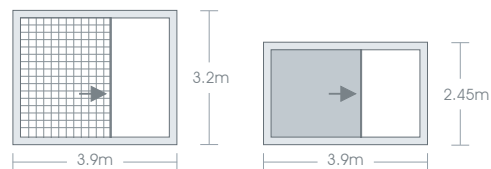

option 1 – screen from right or left  
option 2 – blind from right or left

#### Double system

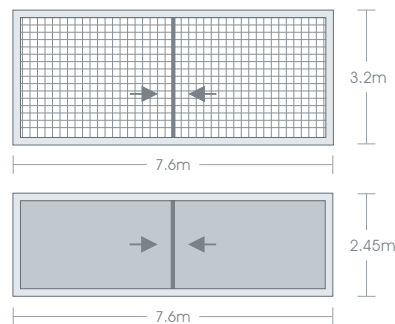

option 1 – screen from right and left  
option 2 – blind from right and left

#### Multi-function system

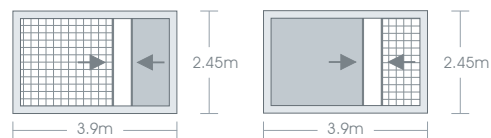

option 1 – screen from right, blind from left  
option 2 – screen from left, blind from right

# Centor innovations ensure STE functions simply and smoothly



The STE solar control blind doubles as a projection screen.



## Considered design

For larger openings between 3.9m wide and 7.6m wide select a double system, choosing an insect screen up to 3.2m high or sun filter blind up to 2.45m high.

The solar control blind doubles as a projection screen for either indoor or outdoor viewing. Mechanisms within the system enable the blind to be left partially open, allowing visitors to pass through the door way without the hassle of opening and closing the blind.

The considered design of the STE Eco-Screen™ complements any large opening. Available in a natural anodised finish, custom colours and real wood veneers, it's mechanisms are concealed within the frame so screen and frame become an integrated unit.

A range of Centor innovations ensure the whole package functions simply and smoothly.

## Load Balancing Technology™

Load Balancing Technology™ (LBT™) (patent pending) allows for the effortless fingertip control synonymous with Centor products. With no crude spring-loading to fight against, the screen's lead-stile remains firmly in any chosen position until further pressure is applied. Load-balancing also means far greater tension across the screen or blind, eliminating any tendency for sag.

## Tight Technology™

Tight Technology™ manufacturing techniques ensure control of the horizontal edges of the screen so they remain straight and tight across the widest spans.

## Shock absorption

In the majority of cases the shock absorption mechanism prevents system damage by redirecting impact away from the screen.

## Self-feeding mechanism

Should winds blow the screen out of the top or bottom channels the fabric will self-feed back onto the roll.

USE STE BLIND WITH  
CLOSED DOORS ONLY



**Real wood veneer**

Select from Western Red Cedar, New Guinea Rosewood, Meranti, Victorian Ash or Surian Red Cedar.

**Natural anodised**

A tough and hard, corrosion resistant metallic finish.

**Powdercoat**

Select from a wide range of gloss, satin and matt powdercoat colours.

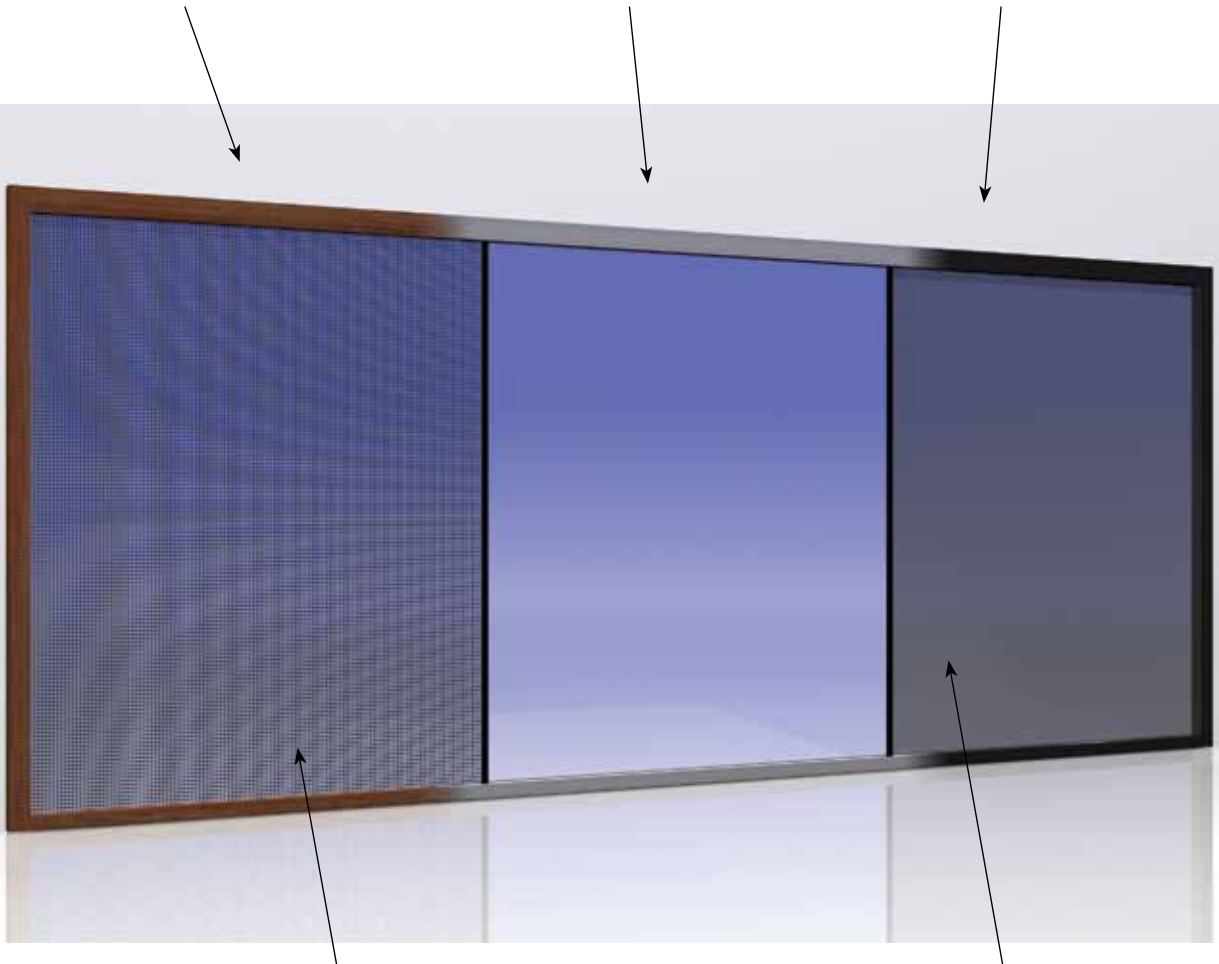

**Insect screen**

Choose flyscreen or small insect mesh made from hardwearing Polyester/PVC.

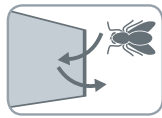

insect protection

**Blind**

Sun filter fabric made from Fibreglass/PVC is available in a range of colours.

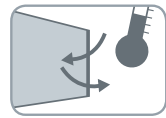

control heat gain & loss

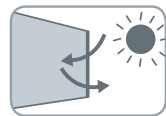

UV protection



projection screen

available in custom colours and real wood veneer finishes

Use with any door or window

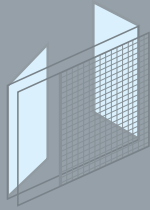

**French doors**

S1E is an ideal solution for screening French doors. Use the screen and blind combination to solve two problems with one system.

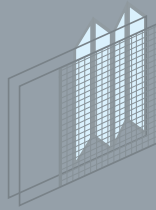

**Bifold doors**

The Centor name remains synonymous with bifold door openings and S1E is ideally suited to use with the full range of Centor bifold systems.

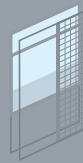

**Windows**

Use S1E with banks of casement, double hung and bifold windows to complement the widest variety of homes and commercial premises.

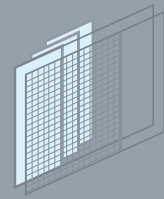

**Sliding doors**

Large sliding doors and stacker doors are an ideal application for S1E. Very large openings can be effortlessly accommodated by an S1E double unit.

**Testing**

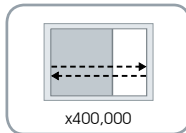

**Fabric choices**

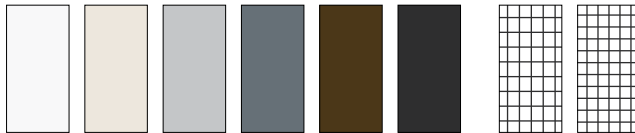

**Sun filter**

**Insect screen**

**Powdercoat colours**



For a full range of powdercoat colours visit [www.centor.com.au/files/upload/powdercoat\\_colours.pdf](http://www.centor.com.au/files/upload/powdercoat_colours.pdf)

Swatches shown are a representation of colour only and may not match actual fabric/powdercoat. Please contact Centor Sales and Customer Service for samples.

corrosion and impact  
tested simulating  
real life use



#### **Built tough and tested**

In developing the S1E, Centor's designers have catered for anything that modern life might throw at this sturdy product.

#### **Materials**

S1E is manufactured in a combination of aluminium, stainless steel, brass and reinforced engineering polymers. The blind is available in sun filter fabric. The tough PVC-coated polyester screen mesh is hardwearing and resistant to damage caused by pets and children.

#### **Testing**

The S1E Eco-Screen™ has undergone cyclic testing to 400,000 operations in a laboratory and extensively exposed to dust, mud, sand and corrosive atmosphere to ensure it is a product for the real world. It has withstood impact testing with a 17kg punching bag 100 times and considerable pushing, poking and prodding to simulate real life usage.

#### **Screen maintenance**

The insect screen material should be cleaned with a soft brush or a damp soft cloth, while the sun filter fabric should be cleaned with warm soapy water and a soft cloth.

Tracking should be regularly cleaned to prevent the build-up of dirt and debris. A vacuum cleaner fitted with a nozzle is effective.

Operating mechanisms are fully self contained and do not require maintenance other than keeping clear of dirt and debris.

#### **Warranty**

Centor offers a 5 year limited warranty on its S1E Eco-Screen™.



# wonderful screening is more important than wonderful doors

James Russell, James Russell Architect



**James Russell**  
James Russell Architect

Leading architect James Russell's private home won major awards and was featured in leading Australian and international magazines, but it wasn't quite finished until he made the final adjustments three years after the home was completed.

The inner-Brisbane home, created between two heritage-listed buildings on what was once an old car park, is full of unique touches including a central open air grassed courtyard surrounded by rooms and living space.

But the beautiful home was attracting some unwelcome visitors – mosquitoes.

"When I designed the house there was nothing available that screened the opening to the courtyard without being invasive. It was important that nothing obstructed the relationship between the house and the open outdoor space," James said.

The availability of the screening system from Centor three years later excited James so much he reemployed the builders to make some adjustments.

As they can be fitted to any existing door or window, James was able to design them into his existing home with minimal adjustments made to the foundations.

"Builders removed small sections of timber and flooring to install the tracks and storage space for the screens.

"As there are no panels or mullions in the screens there is nothing to impair the view or break up the scene."

James feels the screens are almost unnoticeable. "After you've looked into the courtyard there is no memory of the screens you have just looked through. Even inside, we feel we are living in a veranda space," James said.

James' screens are 4.35 metres wide and 2.4 metres high and are located at both ends of his courtyard, protecting the kitchen area at one end and the living space at the other.

"Because we didn't need the screens for security, only comfort, we hope to leave them open for nine months of the year."

With the Queensland summer months being a favourite for mosquitoes after dark, James finds the screen invaluable in protecting his family when needed.

The system is also easy for James' young family to use. "It slides effortlessly with one finger allowing you to control the house and still enjoy the breezes, fresh air and outside noises."

"There is a trend to use big doors and this creates a need for security and the weather to be managed in another way, so that the doors aren't always being opened and closed.

"Wonderful screening is more important than wonderful doors. Prior to the arrival of the Centor screen, I couldn't find nice clean screening that also kept the house open."

James' home won the Robin Dods Award for Residential Architecture at the Queensland Architecture Awards in 2006 and went on to place second nationally. His seven year old business is renowned for designing unique residential homes which blend with Australia's tropical lifestyle.



# the option of 'living outdoors' is now fully protected

Shawn Godwin, Base Architecture



**Shawn Godwin**  
Base Architecture

Leading architect, and founder and director of Base Architecture, Shawn Godwin, has just installed the new S1E Eco-Screen™ from Centor in his own home and sees enormous potential for the screen and blind system in the home and in buildings he designs.

"This system solves all our problems. We push the blind across to protect us from the early morning sun and open it to enjoy the outdoors.

"The industry has been looking for this sort of system for some time. Blinds have always been an issue for architects ensuring they won't clash with windows when open, or look like some clunky add on. These just disappear. They are brilliant.

"The science and research behind opening and closing the Centor screens and blinds is more sophisticated than anything available.

"The very idea of a screen is that you don't want to see the window or door mechanism. Centor's screens are clean-lined and concealed and aesthetically very pleasing.

"In the Australian climate everyone wants to live outdoors but when we design houses that bring in the outdoors they also bring in unwanted sun, insects and prying eyes.

"Privacy and protection from insects and sun has to date meant changing the whole dynamics of the look and feel of the design. The Centor blind and screen combinations change all that. They allow the building to stay true to its outdoor design.

"The option of living outdoors is now fully protected.

"The traditional media room design is changing and increasingly includes windows. The Centor system not only blocks out the light it becomes an option for a projector screen.

"Without products like the Centor screens and blinds it is hard for some of our designs to get sold to the market. It is clearly the best system around.

"Combined with new glazing options that emit heat, the S1E Eco-Screen™ can be explored for full solar reflector benefits.

"This system solves all the problems. The Centor S1E system fits all needs."

Architectural detail / SIE with folding system  
Head and sill detail

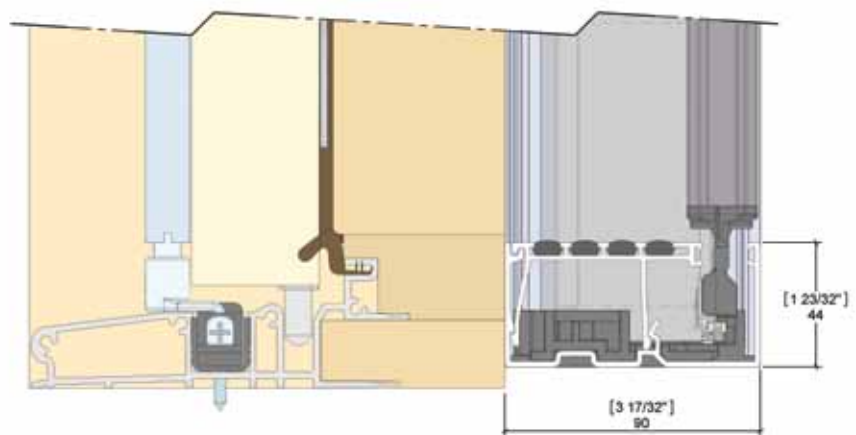
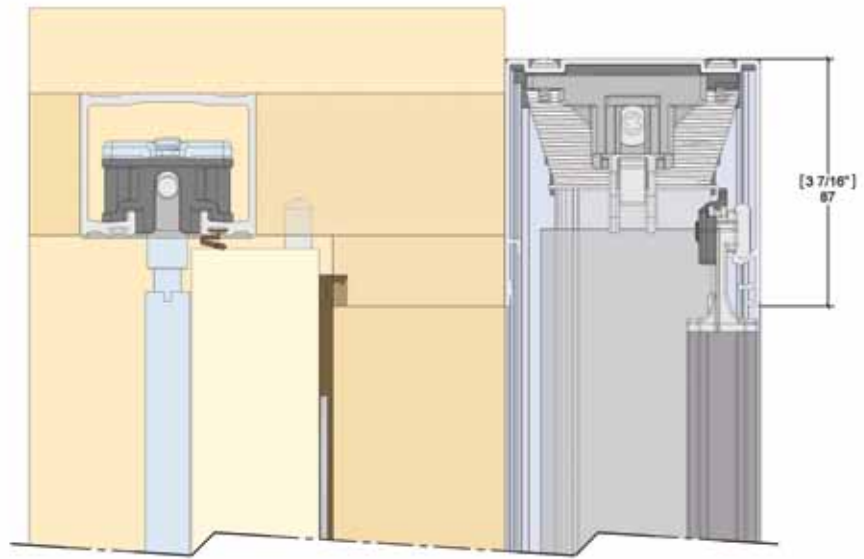

Architectural detail / SIE with folding system  
Jamb detail

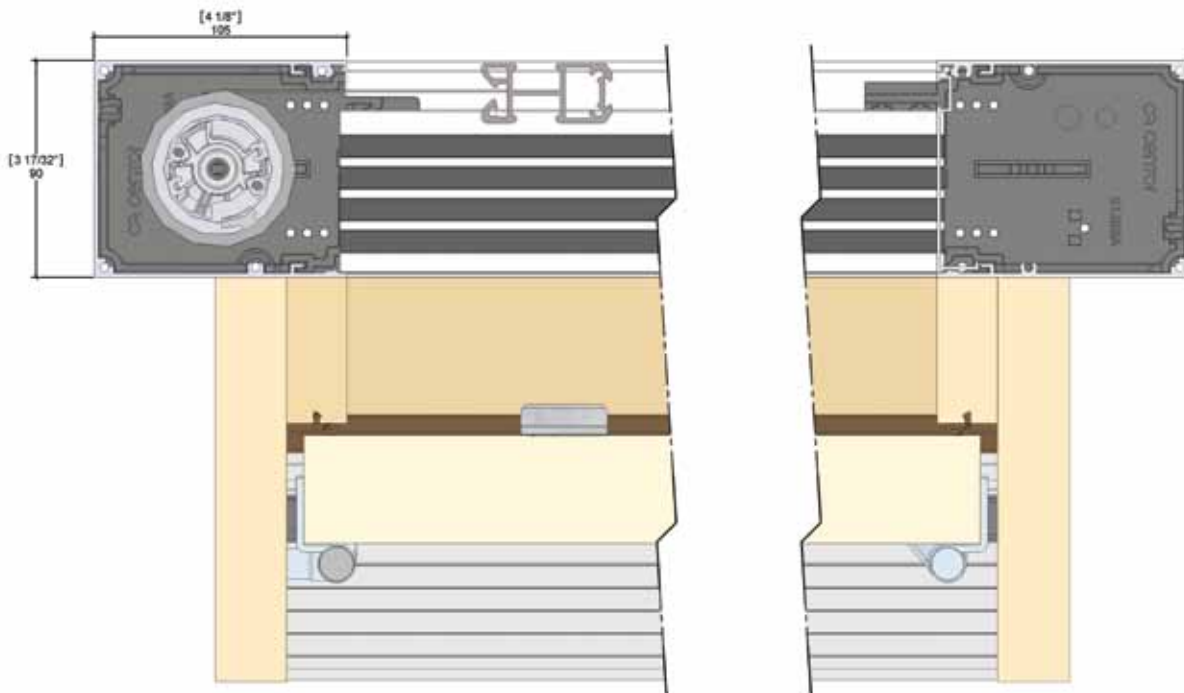

Architectural detail / STE with folding system  
Brick veneer installation – head

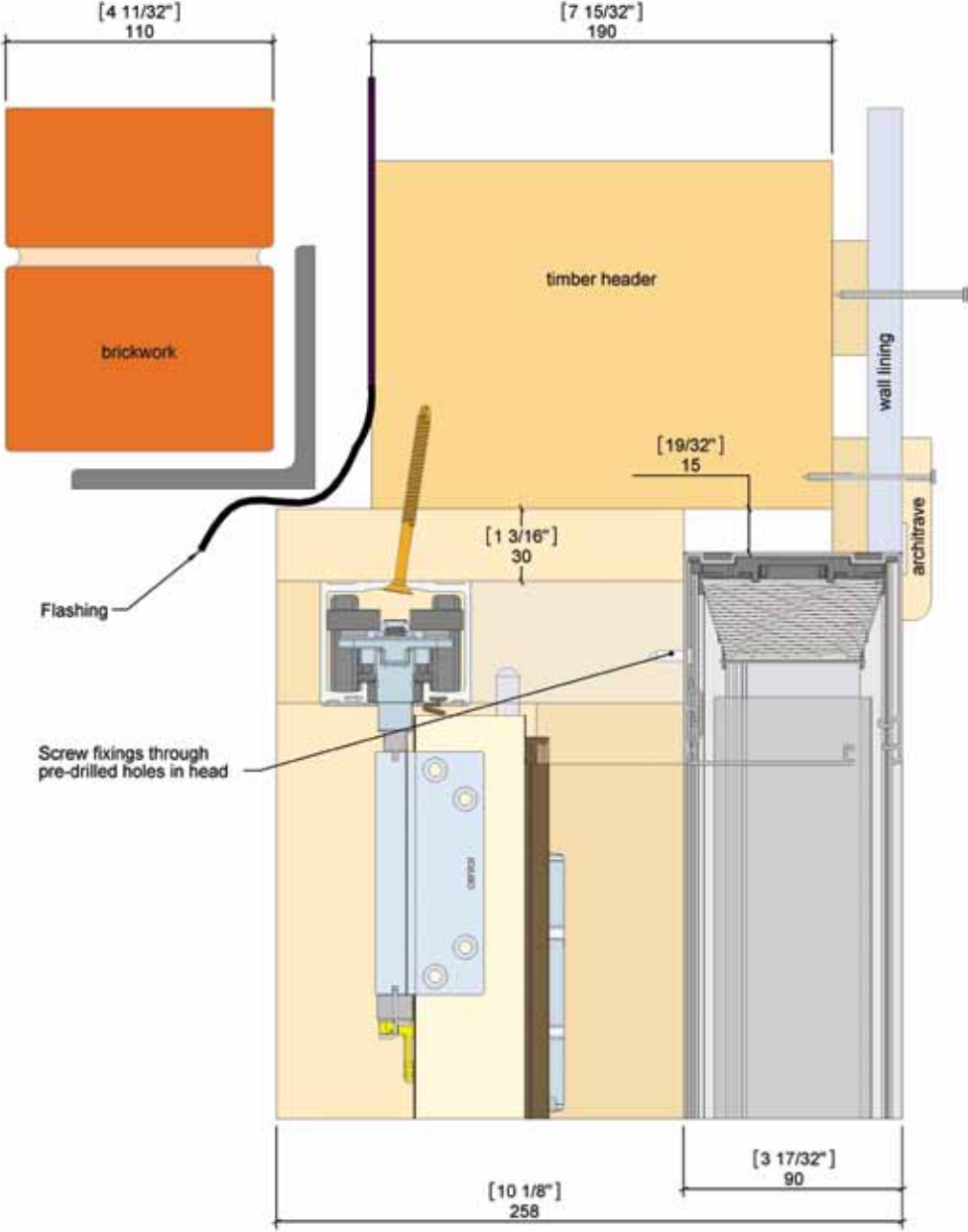

Architectural detail / S1E with folding system  
 Brick veneer installation – jamb

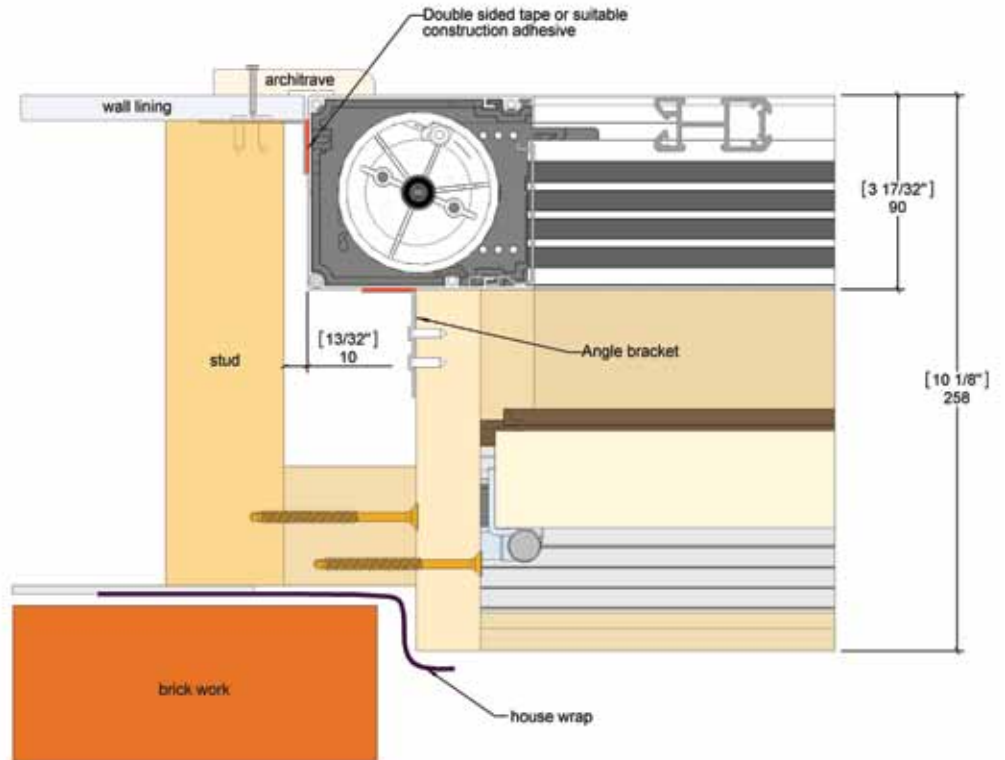

Architectural detail / S1E with folding system  
 Brick veneer installation – sill

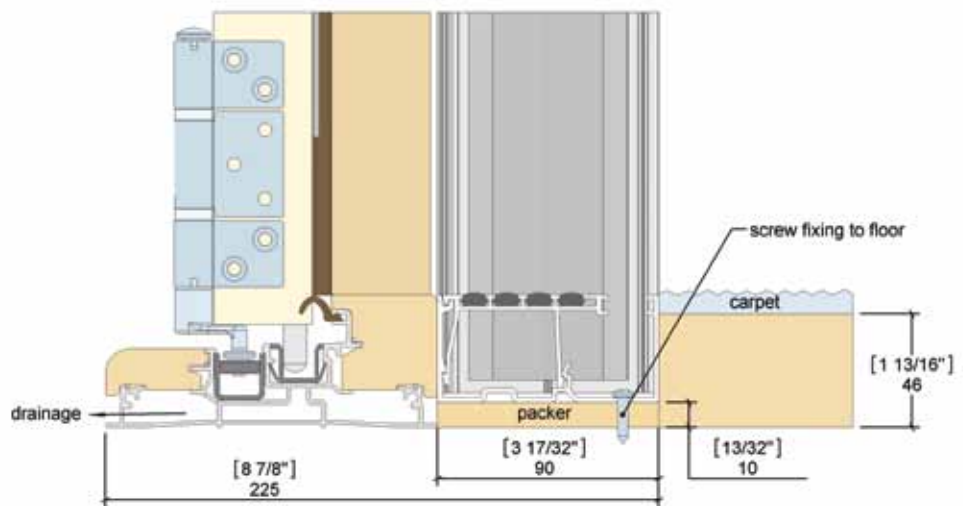

Architectural detail / SIE with folding system  
 Concrete block installation – head

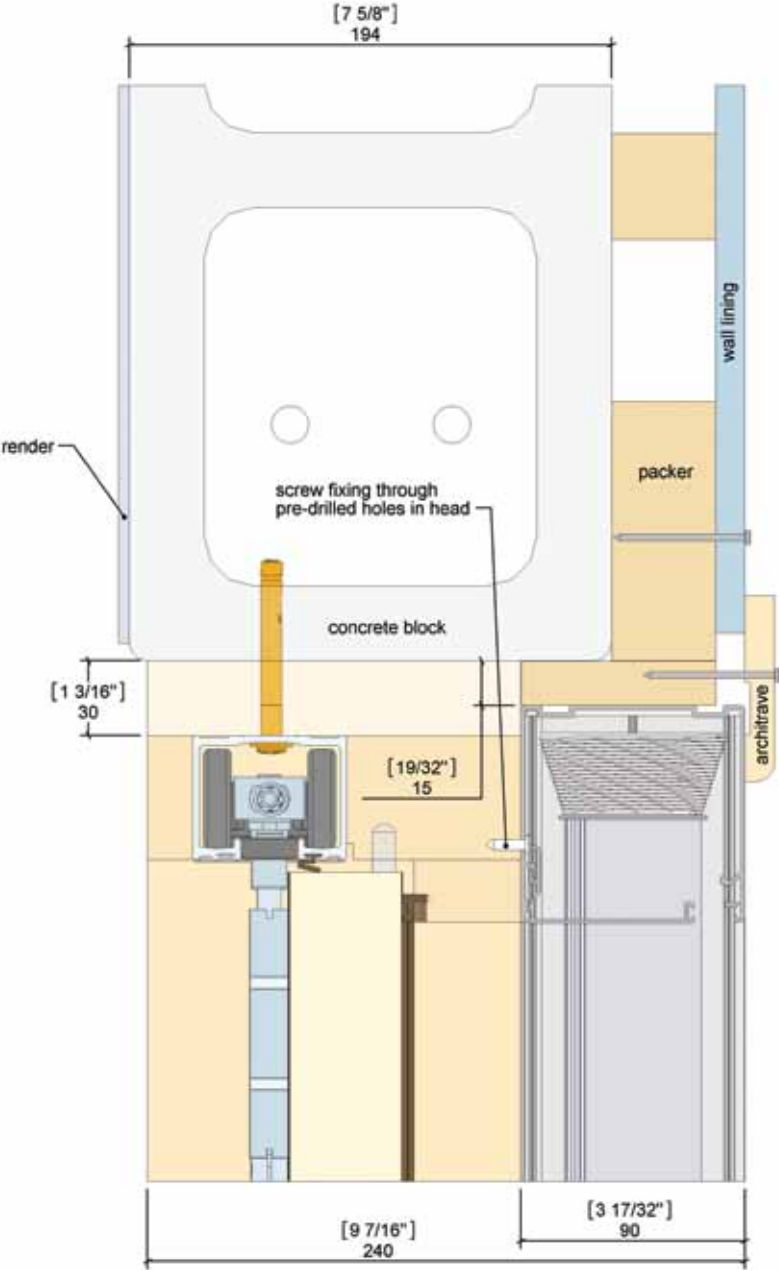

Architectural detail / S1E with folding system  
 Concrete block installation – jamb

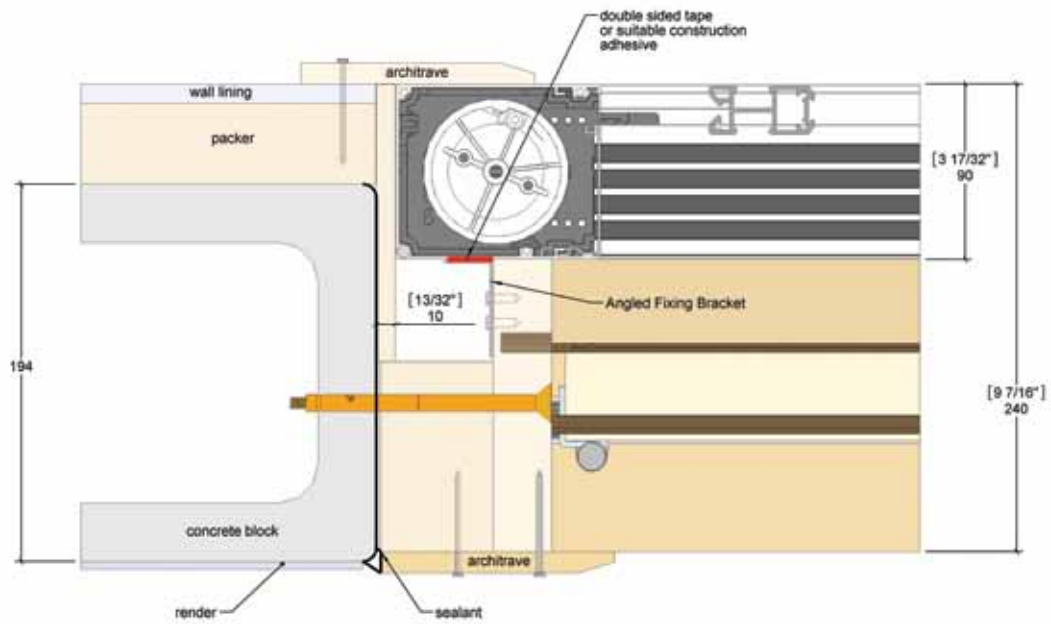

Architectural detail / S1E with folding system  
 Flush installation – sill

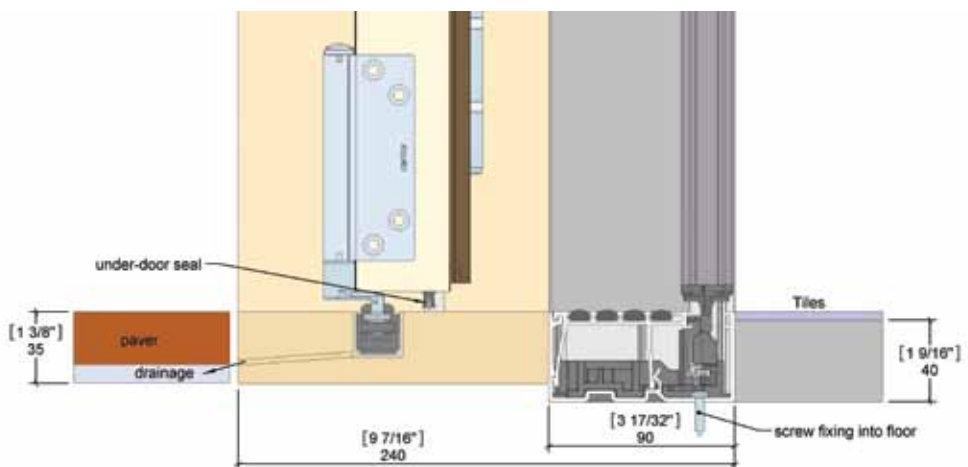

Architectural detail / SIE with folding system  
Timber cladding installation – head

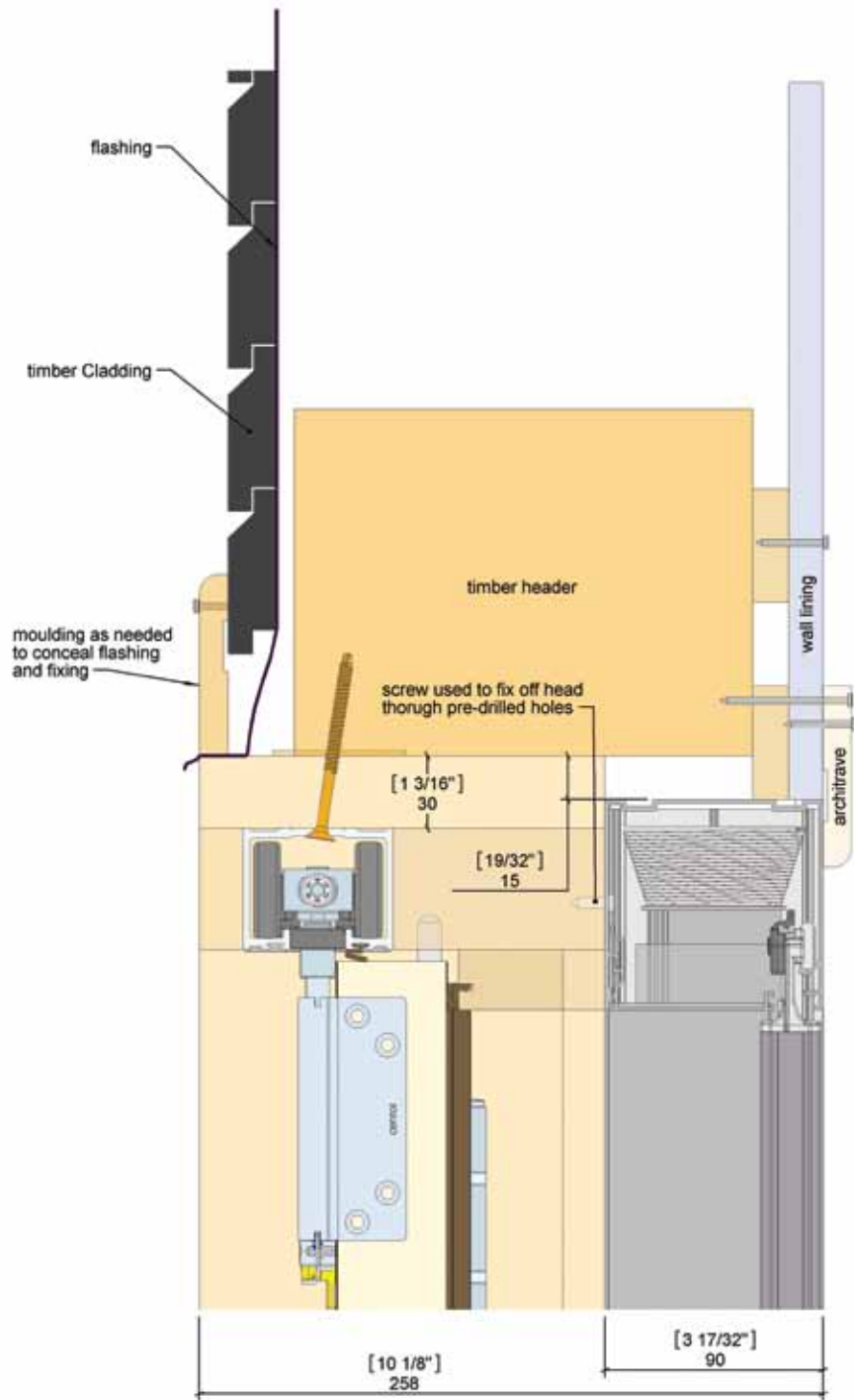



Architectural detail / S1E with folding system  
 Timber cladding installation – jamb

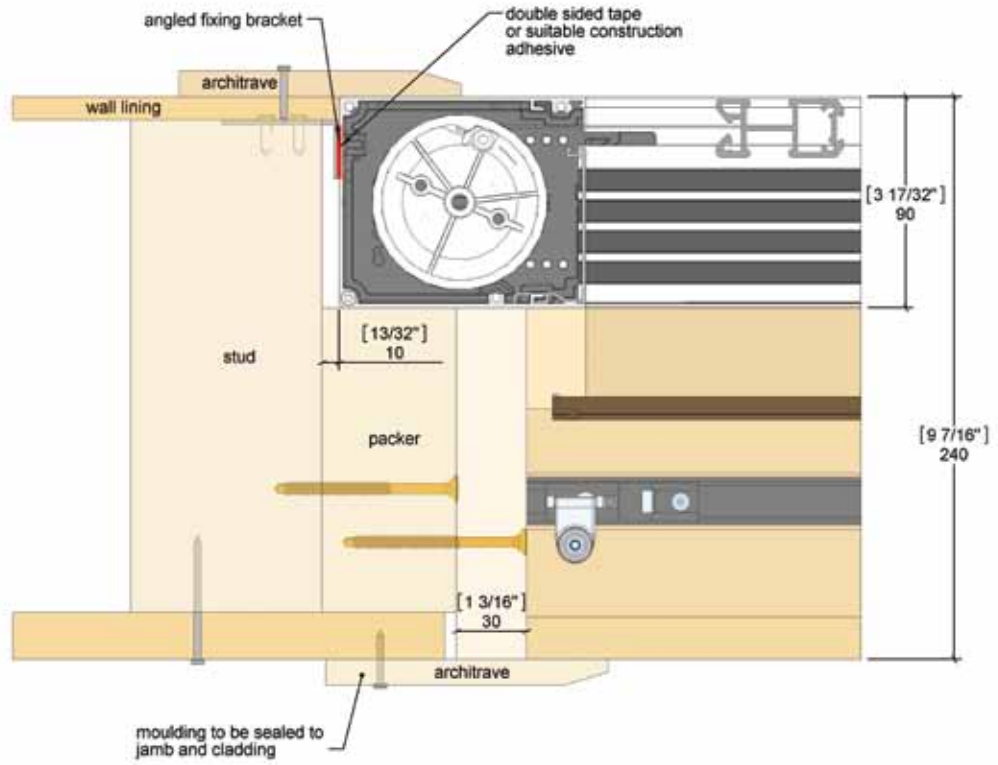

Architectural detail / S1E with folding system  
 Timber cladding installation – sill

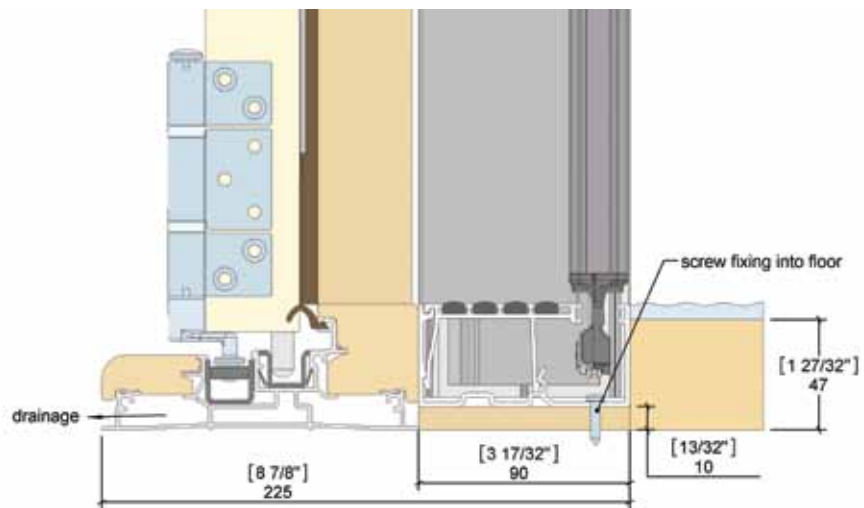

Architectural detail / SIE with sliding system  
Head and sill detail

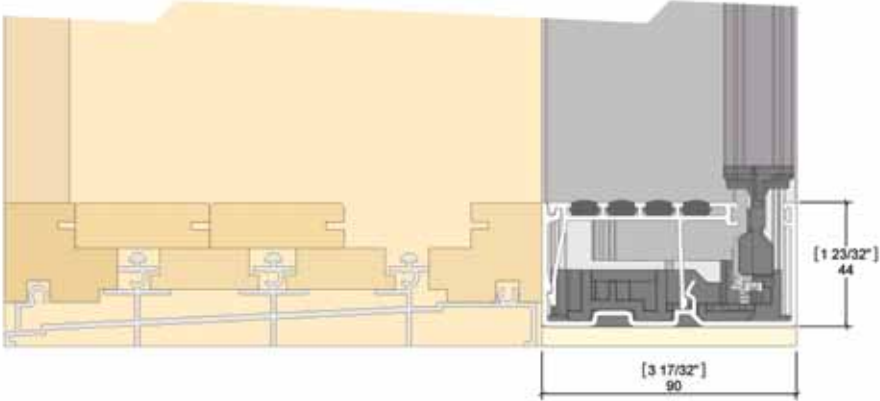
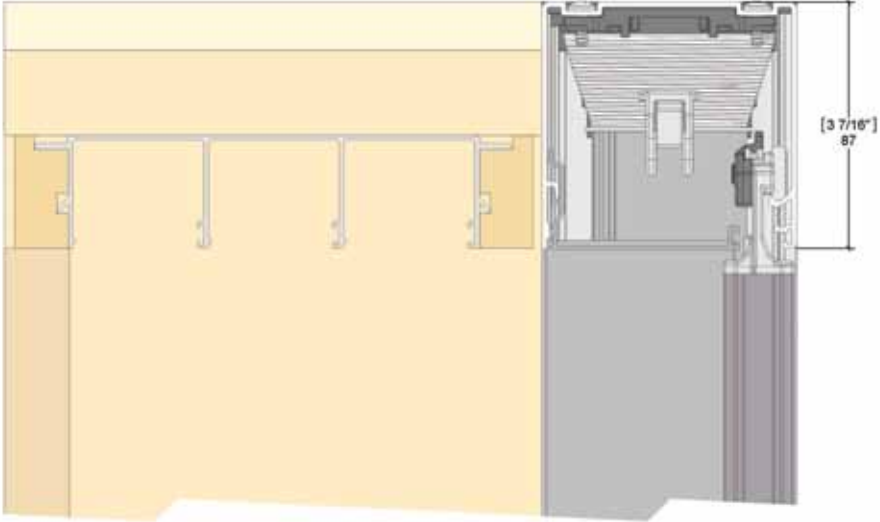

Architectural detail / S1E with sliding system  
Jamb detail

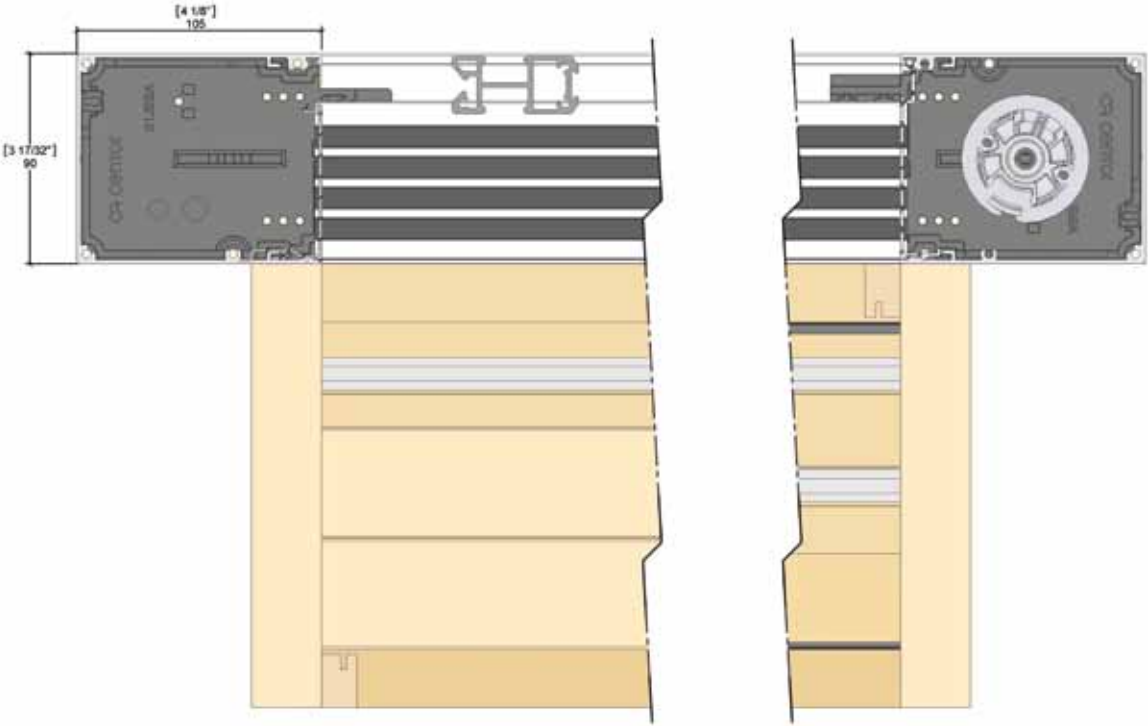

Architectural detail / SIE with sliding system  
Brick veneer installation – head

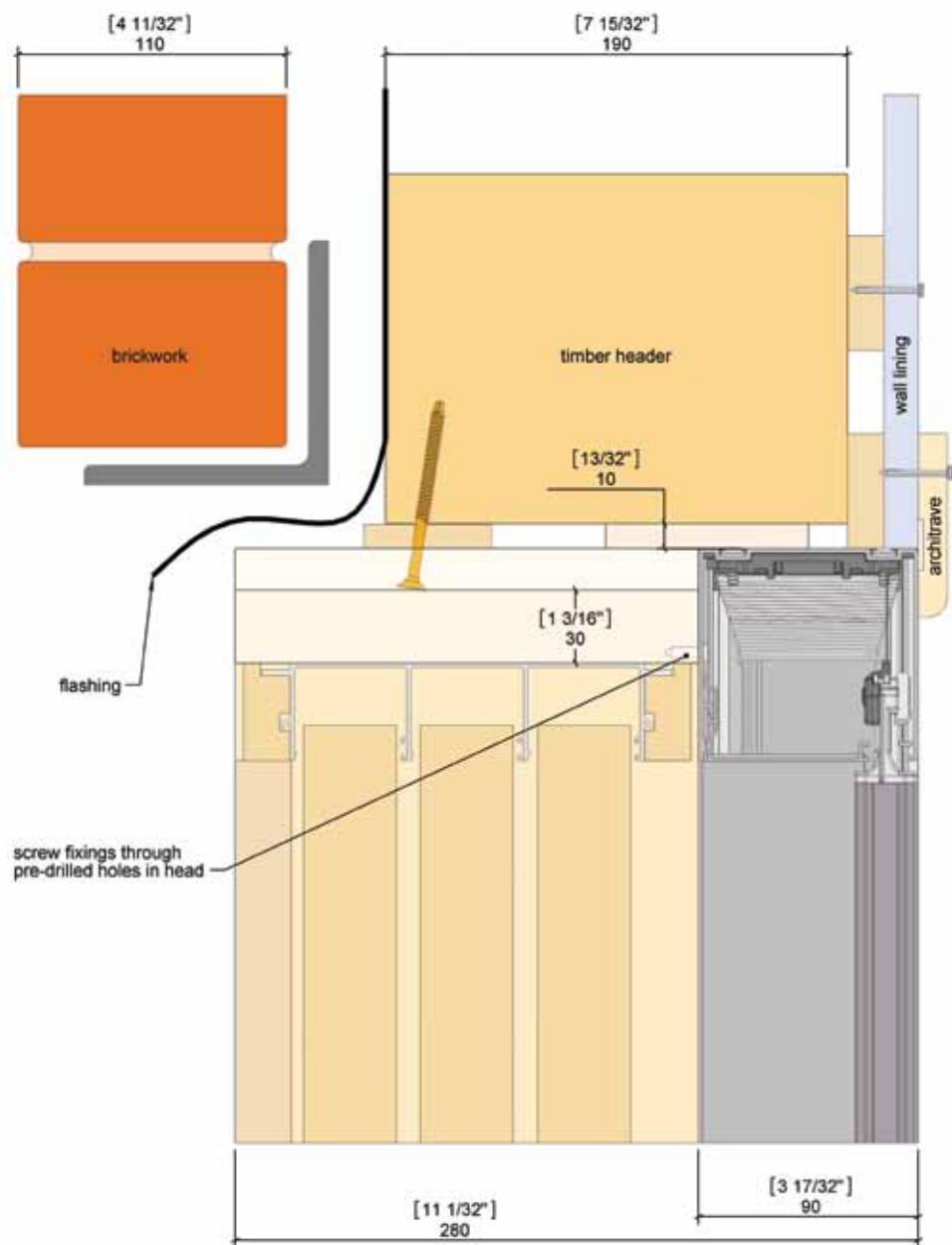

Architectural detail / SIE with sliding system  
 Brick veneer installation – jamb

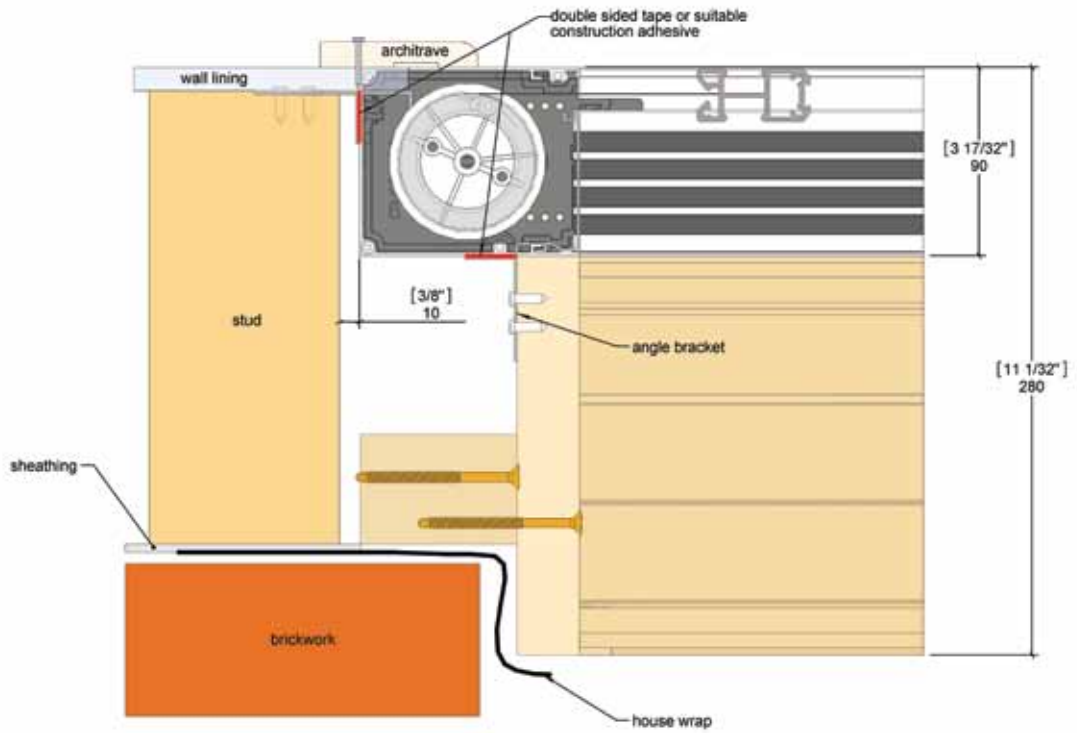

Architectural detail / SIE with sliding system  
 Brick veneer installation – sill

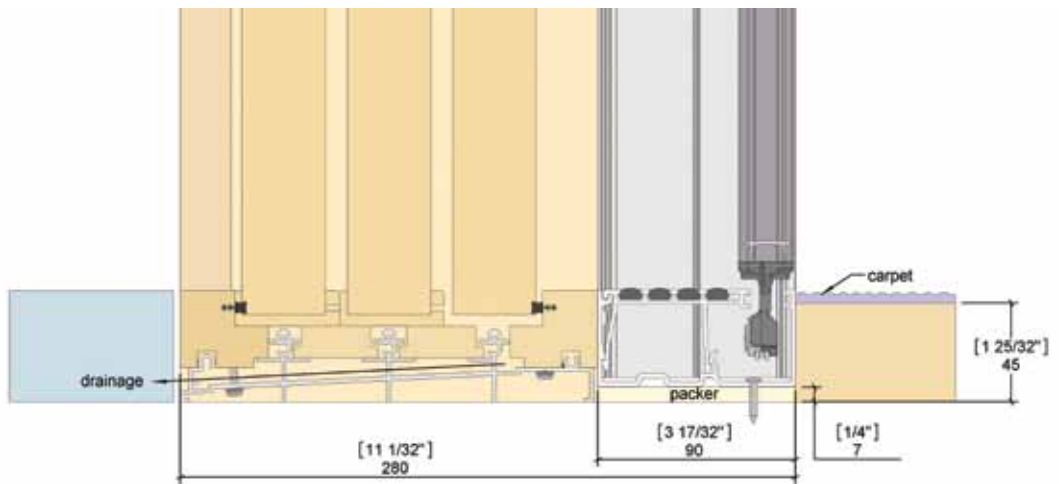

Architectural detail / STE with sliding system  
Concrete block installation – head

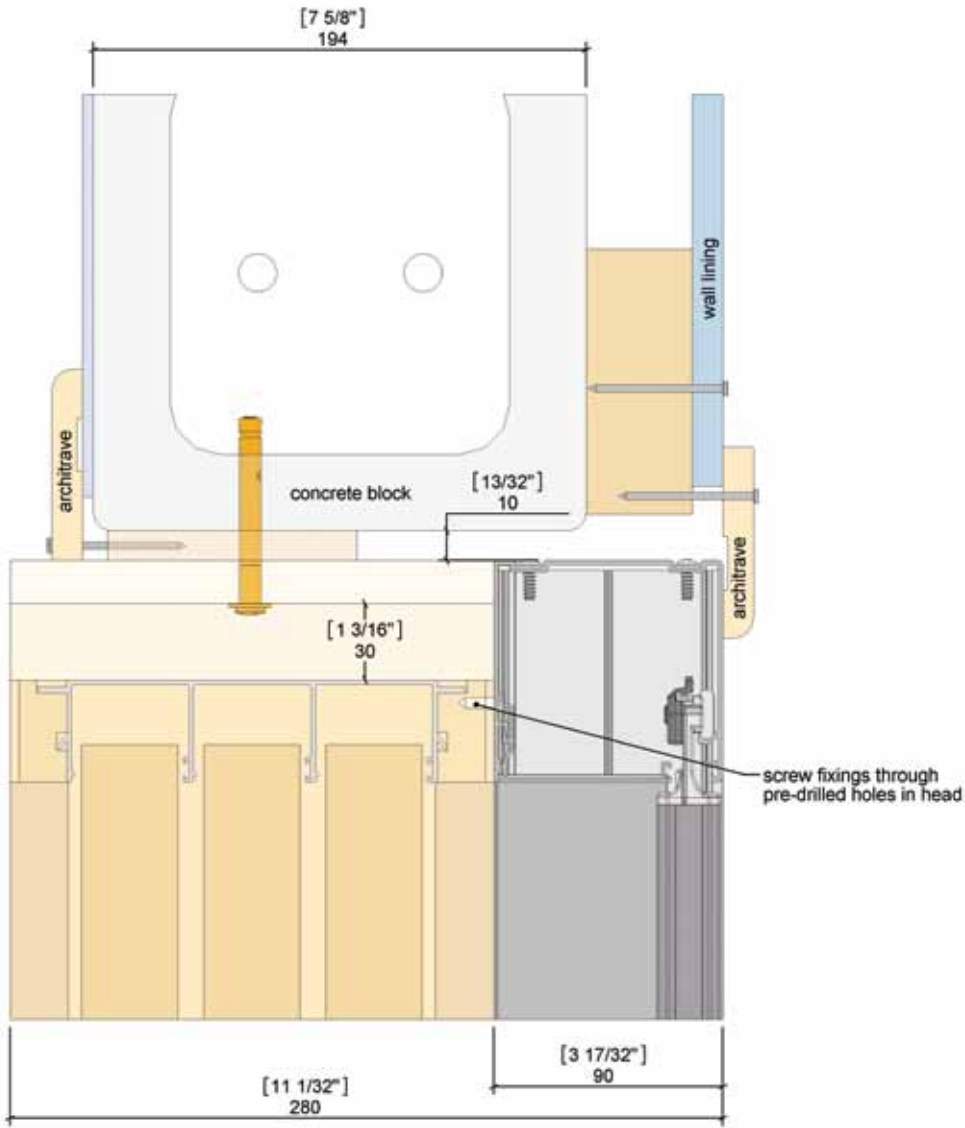

Architectural detail / S1E with sliding system  
 Concrete block installation – jamb

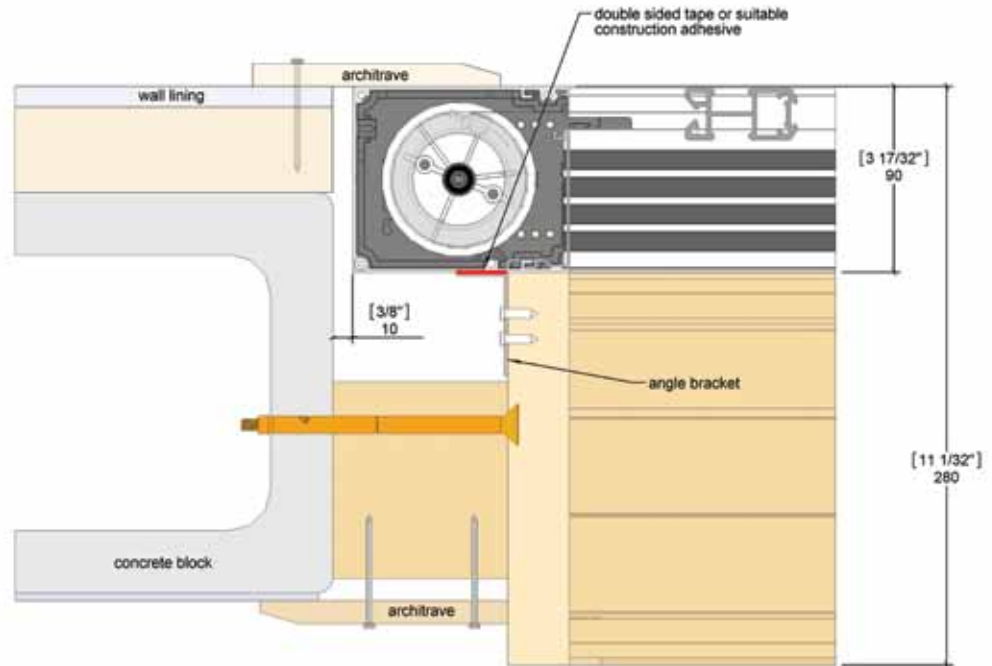

Architectural detail / S1E with sliding system  
 Concrete block installation – sill

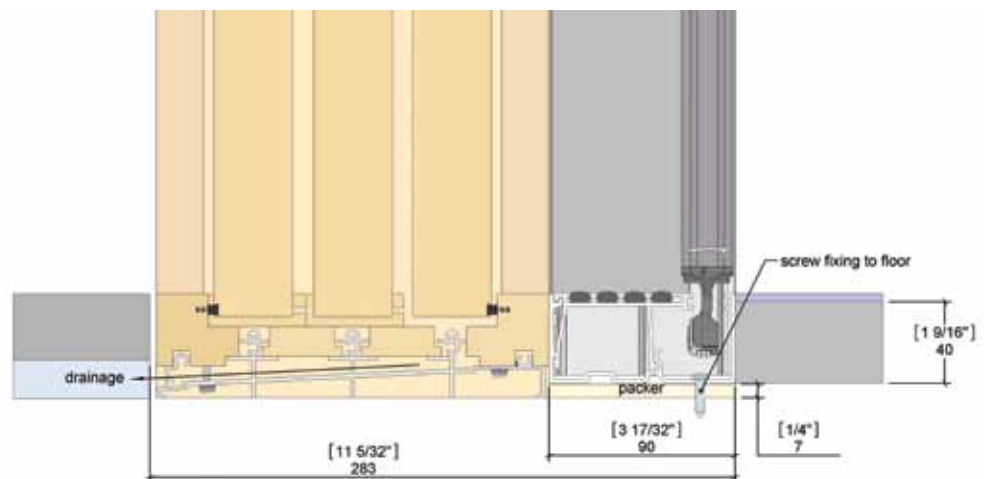

Architectural detail / SIE with sliding system  
Timber cladding installation – head

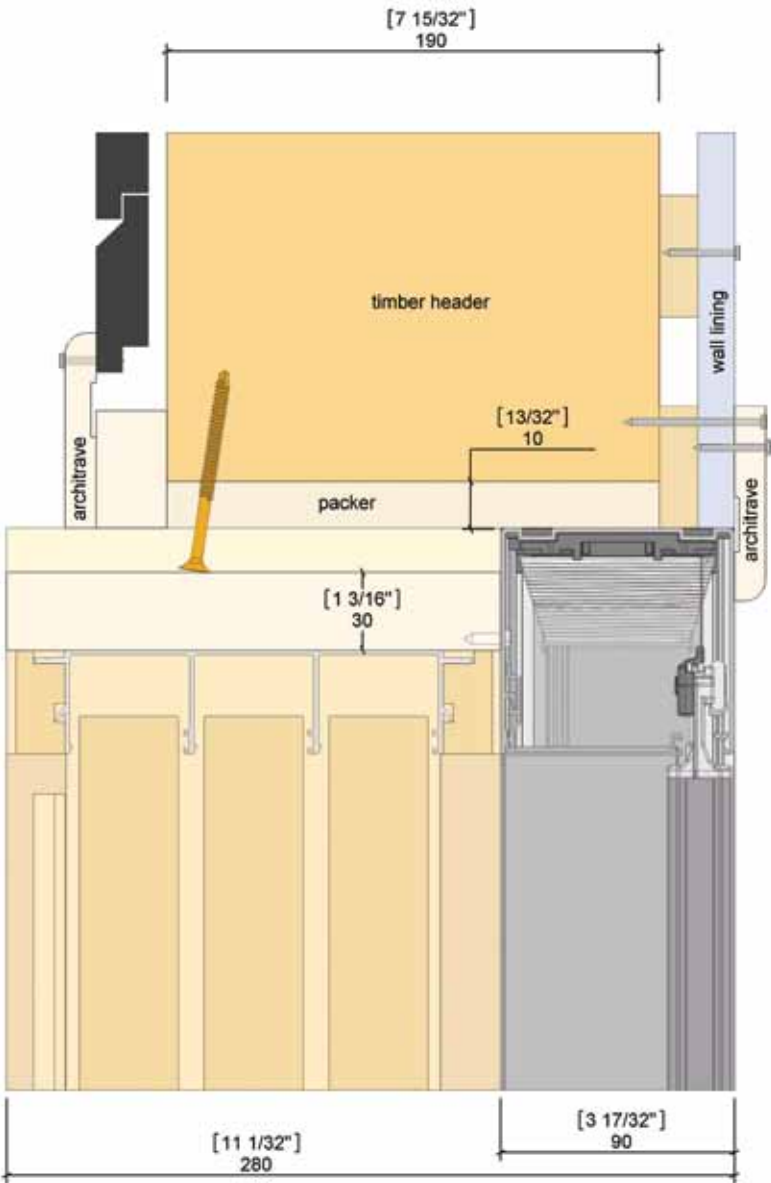



Architectural detail / SIE with sliding system  
Timber cladding installation – jamb

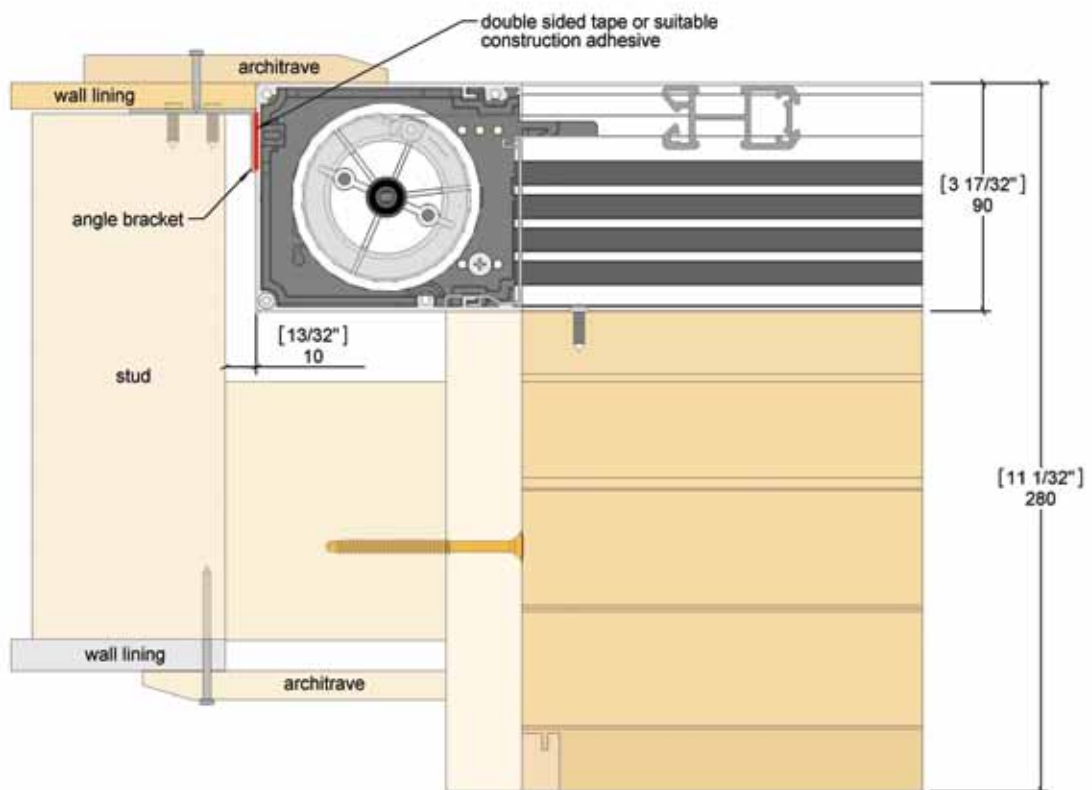

Architectural detail / SIE with sliding system  
Timber cladding installation – sill

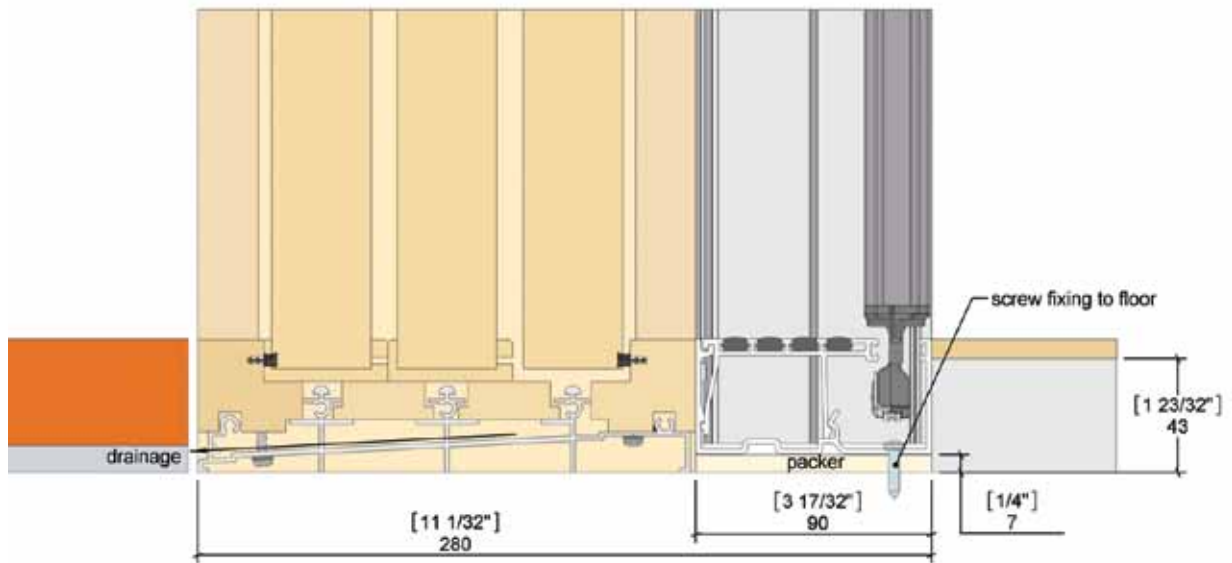

While every effort has been made to ensure the accuracy of the information in this publication, Centor assume no responsibility for errors or omissions or any consequences of reliance solely on this publication.

**Centor Australia Pty Ltd** | ABN 96 009 716 189  
 telephone 1300 CENTOR (1300 236 867)  
 facsimile 1300 CENFAX (1300 236 329)  
 mail@centor.com.au | www.centor.com.au

**Brisbane**

**Centor Australia Pty Ltd**  
 997 Kingsford Smith Drive  
 PO Box 1550  
 Eagle Farm QLD 4009  
 telephone +61 7 3868 5777  
 facsimile +61 7 3868 1201  
 qld.mail@centor.com.au

**Sydney**

**Centor Australia Pty Ltd**  
 12-13/9 Killo Crescent  
 Glendenning NSW 2761  
 telephone +61 2 9208 3200  
 facsimile +61 2 9625 2399  
 nsw.mail@centor.com.au

**Melbourne**

**Centor Australia Pty Ltd**  
 28 Keysborough Close  
 Keysborough VIC 3173  
 telephone +61 3 9709 0300  
 facsimile +61 3 9798 1645  
 vic.mail@centor.com.au

**Adelaide**

**Centor Australia Pty Ltd**  
 4/2 Endeavour Drive  
 PO Box 285  
 Port Adelaide SA 5015  
 telephone +61 8 8304 2577  
 facsimile +61 8 8304 2599  
 sa.mail@centor.com.au

**Perth**

**Centor Australia Pty Ltd**  
 2/34 Juna Drive  
 Malaga WA 6090  
 telephone +61 8 9241 7600  
 facsimile +61 8 9249 7445  
 wa.mail@centor.com.au

**Launceston**

**Access Hardware Pty Ltd**  
 42 Invermay Road  
 Mowbray Heights TAS 7248  
 telephone +61 3 6331 2533  
 facsimile +61 3 6331 2733  
 accesshw@bigpond.net.au

**Hobart**

**Access Hardware Pty Ltd**  
 21 Brisbane Street  
 Hobart TAS 7000  
 telephone +61 3 6231 9926  
 facsimile +61 3 6231 9927

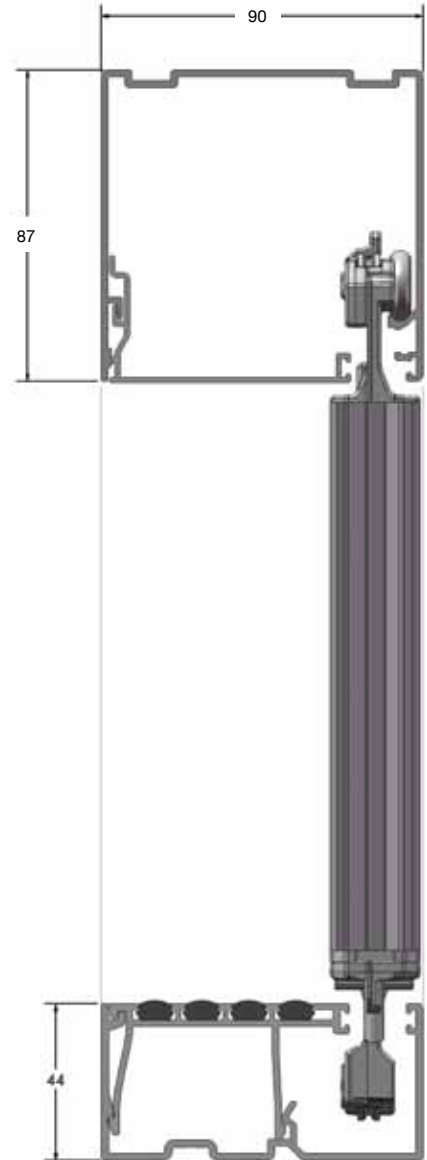
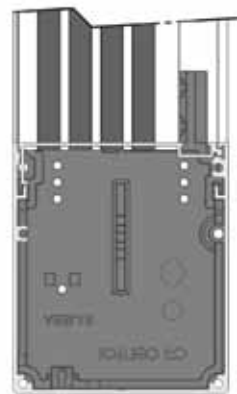
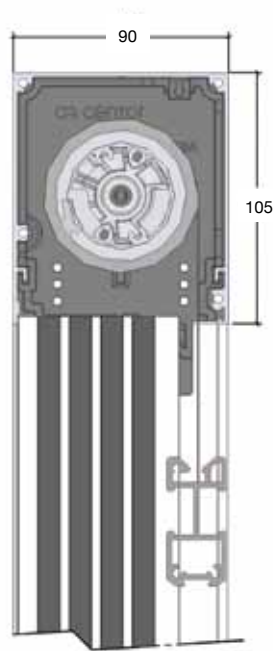

214-100-030-006

Sectional side view (screen roll omitted in the drawing for clarity)